

Section 24

Main Rotor Blades

Procedures covered in this section:

Sand wood filler blocks; make and install wood end plugs; install tip weights; check trailing edges; paint the blades; cut out and install pitch horns; install aligner blocks and thrust blocks; mount retention straps; mount blades on the helicopter and perform static lead/lag adjustment and static balance.

Cards used in this section:

HARDWARE CARD	E20 CARD 2F	E49 CARD 1F
E20 CARD 1F	E20 CARD 3F	E49 CARD 2F

Prints used in this section:

E20-2000	E49-2000	E49-2002
----------	----------	----------

Templates used in this section:

None

Tools required for this section:

Air or electric drill	Grinder	Protractor level	Straight edge
Band saw or hacksaw	Level	Ruler	Torque wrench
"C" clamps	Pliers	Screwdrivers	
Dial calipers	Pop rivet gun	Spring clamps	

Drill bits of the following sizes: 3/32", 1/8", 3/16", 1/4", 5/16", #32, #47
Ratchet with sockets of the following sizes: 3/8", 7/16", 1/2", 9/16", 7/8"
Wrenches of the following sizes: 3/8", 7/16", 1/2", 9/16", 7/8"

Notes:

- BOLTS:** The following torques are to be used on the rotor system:

9/16" retention bolts	70 ft. lbs.
5/16" retention strap bolts	14 ft. lbs.
5/16" aligner block bolts	22 ft. lbs.
1/4" adjusting bolts	7 ft. lbs.
1/4" allen screw	7 ft. lbs.
- FLIGHT TRAINING:** It is recommended at this time to attend flight training to review the rigging of the rotor system and controls.
- WARNING:** The engine can be started without the main rotor blades installed, however:
 - The pitch control rods of the rotor system must be removed from the rotating swash plate.
 - All remaining components of the drive system must be connected.
 - The engine must not be operated above 2000 RPM.
 - The engine must not be run at idle for extended periods of time.

Photo #1

The blade straps are made at the factory as a set. Remove the straps, and mark them to ensure that each set will be reassembled in the right order. Measure the wood filler blocks on the root end of the blades.

Note: The chord line is scribed on the end of the blade.



Photo #2

The filler blocks must be sanded to match the dimensions on print E20-2000. Using a #2 pencil with normal pressure, cover the surface to be sanded.

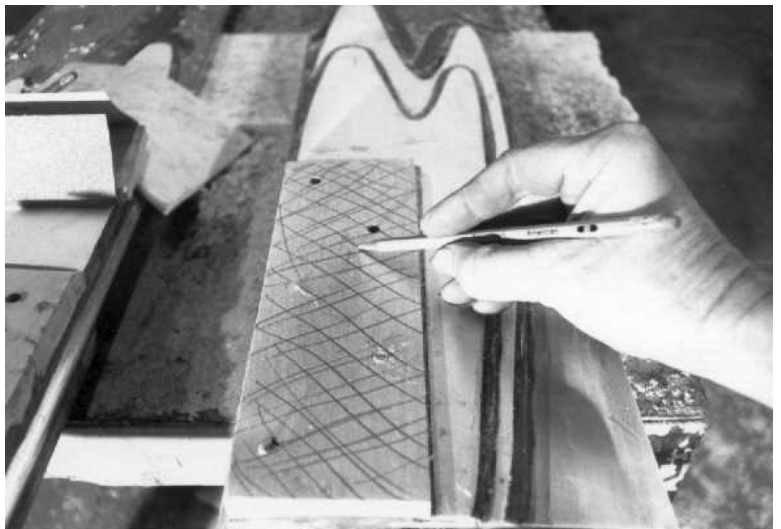

Photo #3

Use sandpaper wrapped around a block of wood for even sanding.

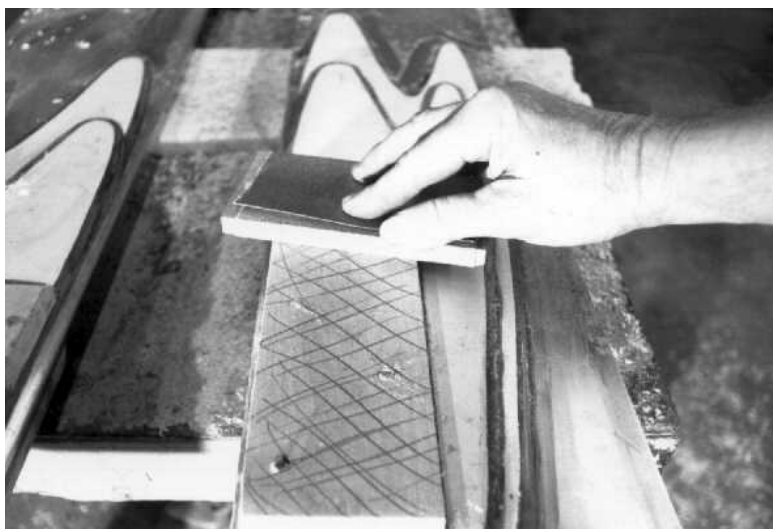



Photo #4

Sand until all signs of the marks are gone. This method normally removes .002". After sanding, verify the following measurements:

1. Overall thickness 2.250".
2. Chord line centered.
3. Top and bottom wood surfaces and chord line are parallel.



Photo #5

Refer to drawing E20-2000. With a felt marker and straight edge, mark where the trailing edge of the blade is to be cut.



Photo #6

Use a hacksaw to cut on the line.

Photo #7

Trailing edge cut off.



Photo #8

Place the wood end plug next to the rotor blade and draw a line even and parallel with the spar.



Photo #9

Draw a line even and parallel with the rotor blade where the top and bottom skins meet.

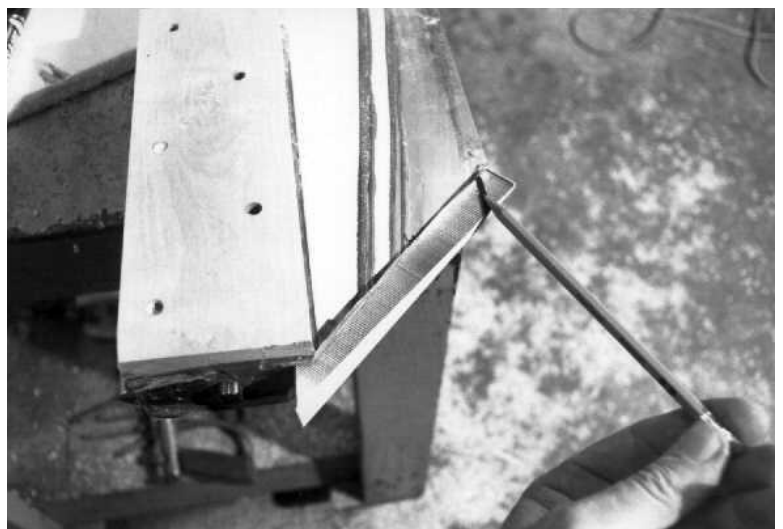



Photo #10

Mark the edge of the airfoil and fit the wood plug in the root end of the blade.

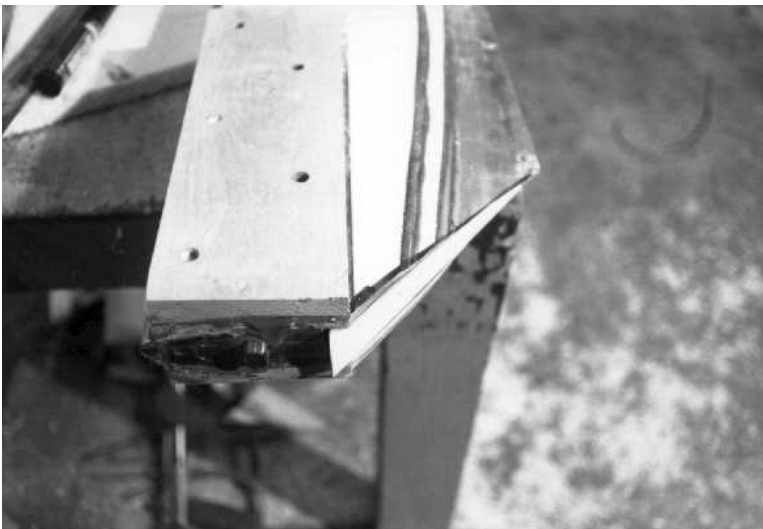

Photo #11

Wood plug fitted into airfoil.



Photo #12

Locate and drill the airfoil and wood plug for the screws.

Photo #13

Sand the mating surfaces and apply 3M 2 part epoxy adhesive, also called "blade glue" (found on E33 CARD 1F).



Photo #14

Install the wood plug and finish the root end of the blade. Drill the vent holes in the wood plug.



Photo #15

Hold the wood for the tip end plug against the blade and trace the airfoil on the wood.



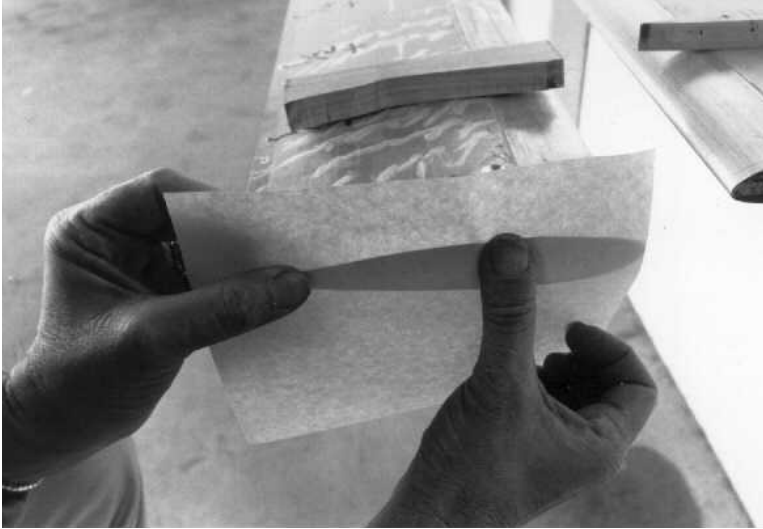

Photo #16

Hold a piece of paper against the end of the blade and use your finger to trace the outline of the spar and skins.



Photo #17

Cut out the paper pattern and transfer the outline on the wood end plug. Cut out and fit the plug to the rotor blade.

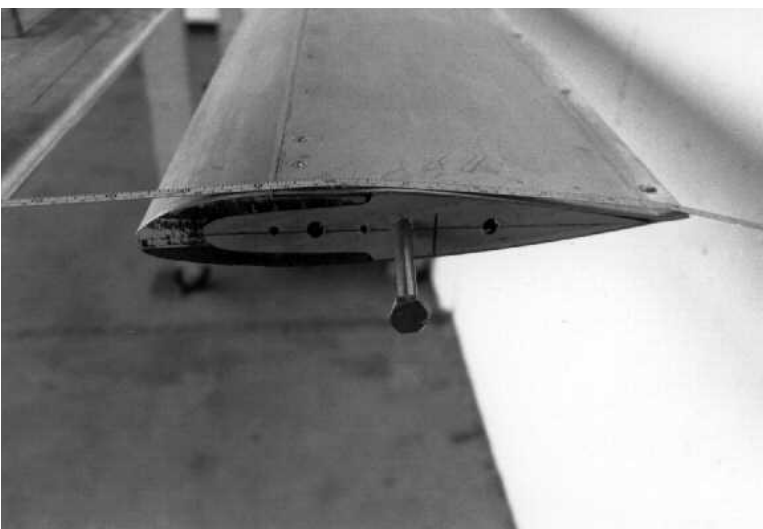

Photo #18

Drill the 1/4" vent holes as shown on print E20-2000. In between the vent holes, drill two 1/8" holes for the sheet metal screws, if needed, for dynamic balancing.

Photo #19

Drill holes for the wood screws. Use a #47 drill for the pilot and a #32 drill for the shoulder of the screw. Use a 1/4" bolt in the vent hole to remove the end plug easily. Do not glue the end plug in place until after the rotor system is balanced.

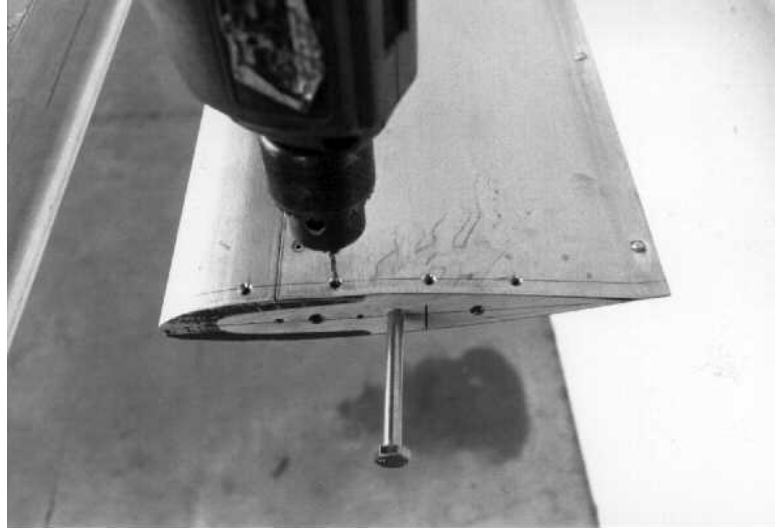

Photo #20

Cut the tip weight material in half and drill the two 1/4" holes as shown on print E20-2000.

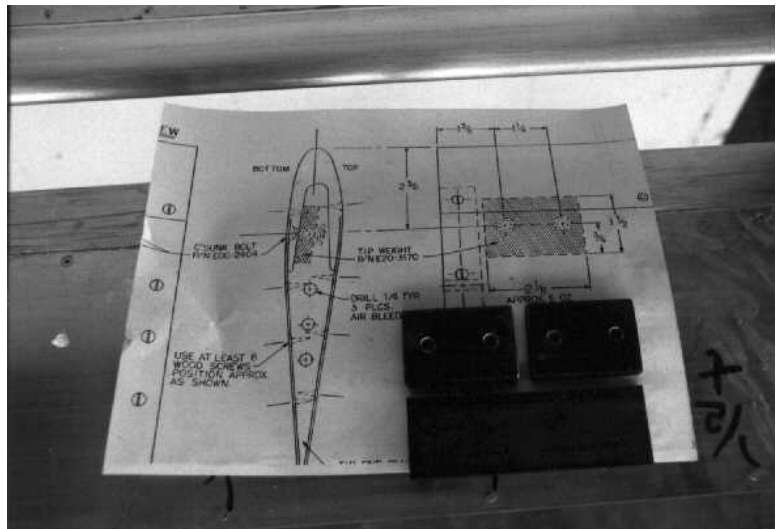
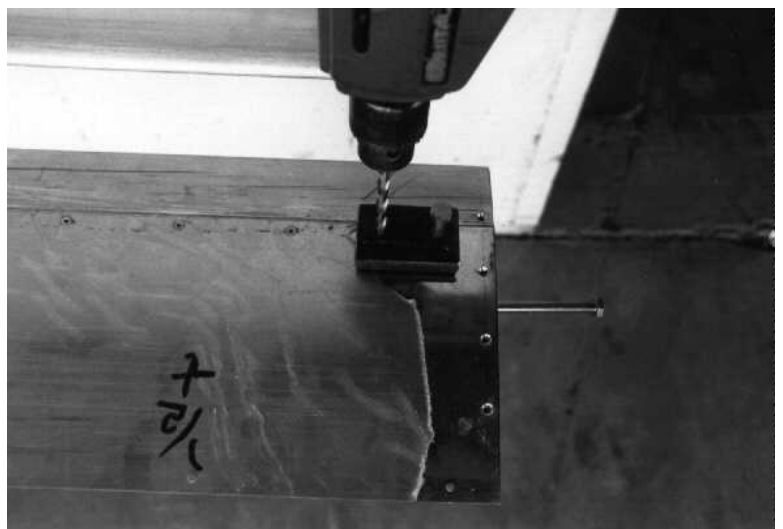

Photo #21

Locate and drill one attachment hole in the bottom side of the spar. Install a bolt in the hole, then use the tip weight as a template to drill the other hole.



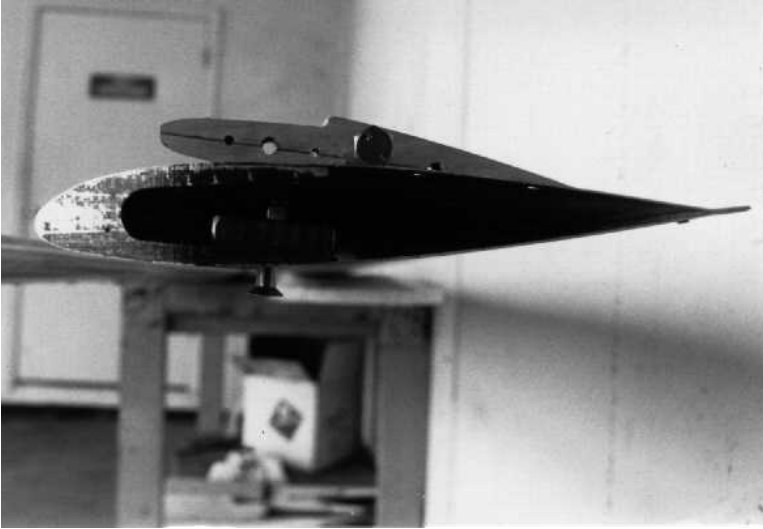

Photo #22

Tip weight shown installed in the rotor blade.
Note: The rivet tails extending inside the blade where the tip weight is located can be removed to allow the weight to sit flush.



Photo #23

Make a reflex trailing edge template and check each blade from end to end. The trailing edge must be the same along the entire length of the blade.

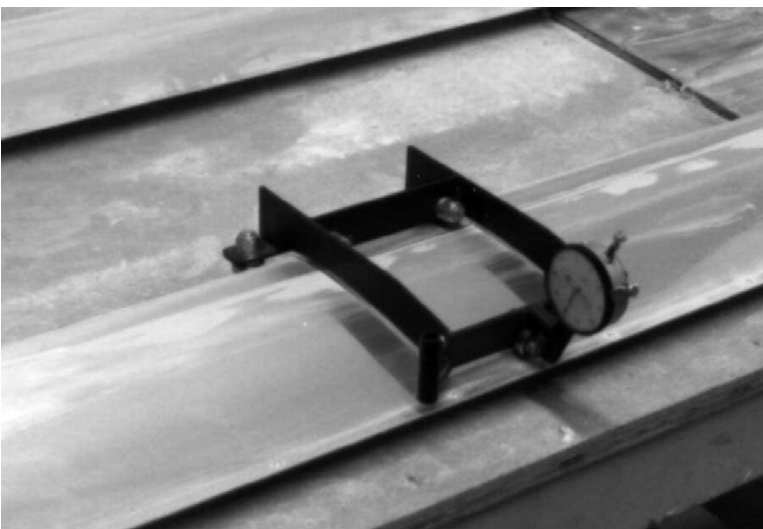

Photo #24

A more precise method of adjusting the trailing edge is to use a dial indicator mounted on the reflex edge fixture, available from the parts department. Detailed instructions are provided with the fixture. After adjusting the trailing edges, clean the blades, using the thinner for the paint that you will use. Then paint the blades.

Note: Do not use acetone to clean the blades.

Photo #25

Cut out and deburr the pitch horns.

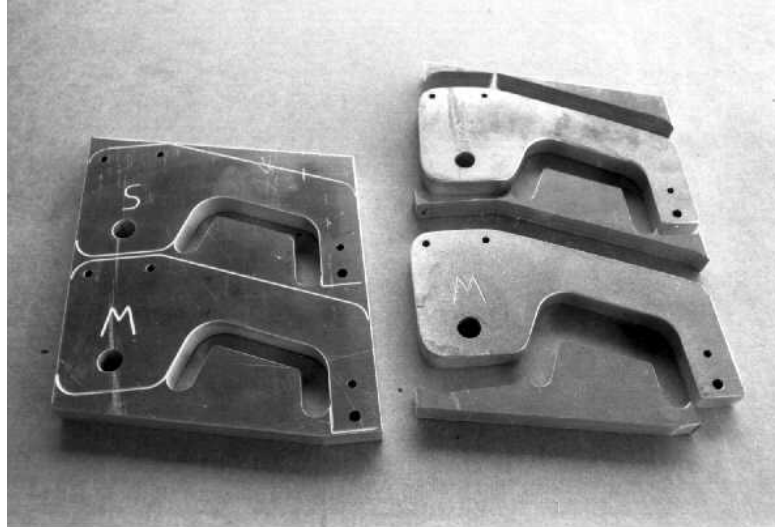

Photo #26

Fit the pitch horn clevis to the pitch horn. It may be necessary to radius the corner of the pitch horn so there is no gap between them when bolted together.

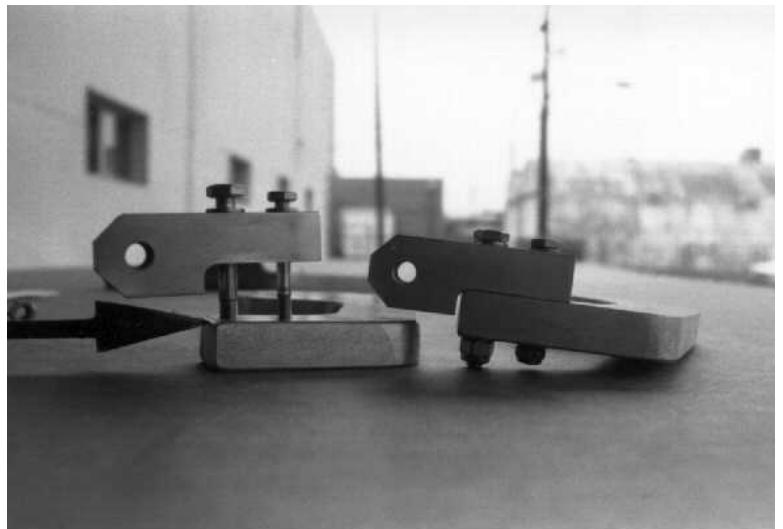

Photo #27

Each aligner block is marked with a "T" which indicates the top. When installed, it must be mounted with the top up so that the adjustment bolts will align with the root stud on the rotor blade (arrow). It is possible that the stud could move if bumped during handling. Before installing the aligner blocks, measure the distance that the stud extends from the end of the blade. It should measure .300" plus or minus .020" to ensure proper contact with the bolt.

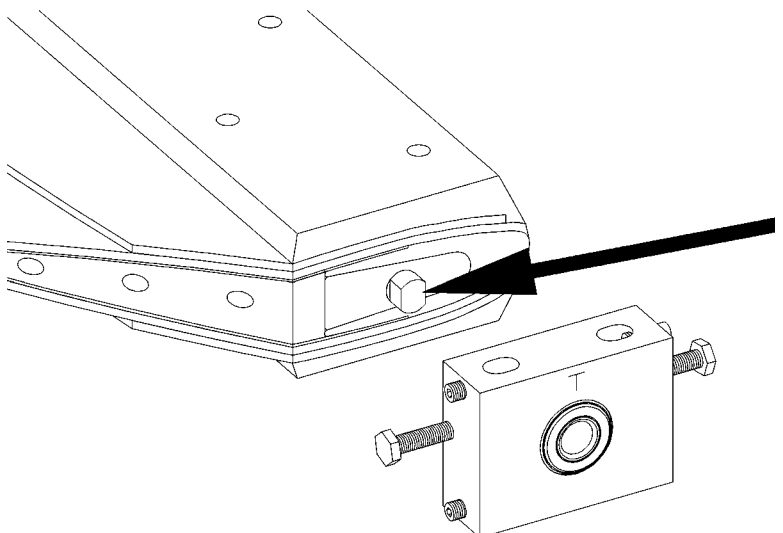



Photo #28

This shows the thrust blocks. There is a master marked with an "M" which goes on the end of the hub stamped with the serial number. The slave is marked with an "S". Both blocks have a top side.

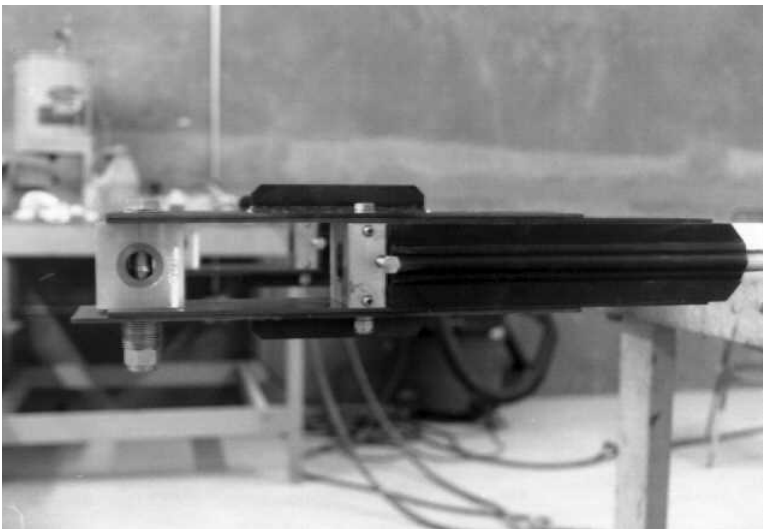

Photo #29

Deburr and round the edges of the blade straps. Put the thrust block and aligner block between the retention straps. If you do not have enough 9/16" washers to tighten the 9/16" nut, you can use the pitch horn on one set of straps.

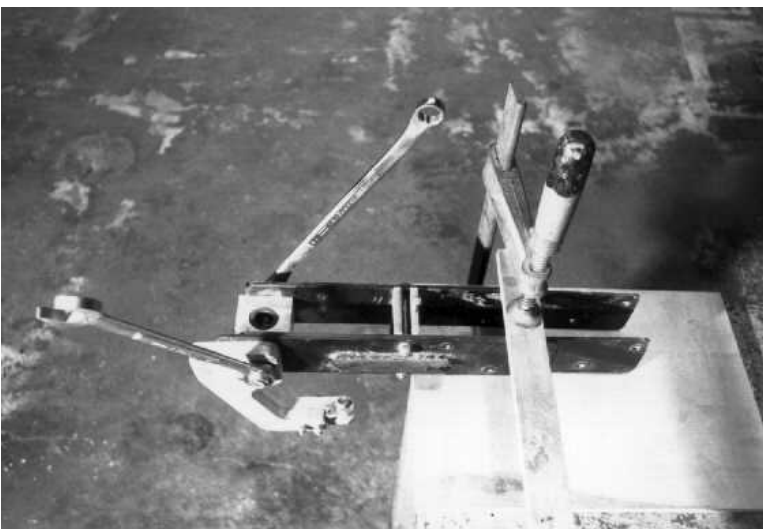

Photo #30

Place the retention strap assembly on a flat surface. Tighten the 9/16" bolt and the two 5/16" bolts to maintain alignment when mounting the assembly on the blades. Turn the back of the thrust block towards the edge of the strap that has the three holes. This will make it possible to measure to the edge of the 9/16" bolt when mounting the assembly to the blades.

Photo #31

With a file or grinder, roughen the surfaces of the strap to be glued so that the glue will adhere. Apply a thin layer of glue to the filler block and the mating strap, then slide the assembly so that the last bolt hole in the strap is at the end of the blade. Using a clean rag, wipe the excess glue from the end of the blade and strap. Use grease in the corner of the aligner block and strap to prevent them from being glued together.

Note: Use 3M 2 part epoxy adhesive, also called "blade glue" (found on E33 CARD 1F).



Photo #32

To mount the retention straps on the rotor blades in the correct location, do the following:

1. Slide the assembly in place. Drill through the hole (arrow) with a 5/16" bit and install the bolt.
2. Place a straight edge against the leading edge of the blade.
3. Adjust the aligner block bolt to achieve the correct distance between the leading edge of the rotor blade and the center of the 9/16" retention bolt. (1.985" to 1.990").

Note: The chord line of the rotor blade, the straight edge and the caliper must all be level when making this check. The distance must be the same on both blades. If this cannot be achieved, contact RotorWay customer service.

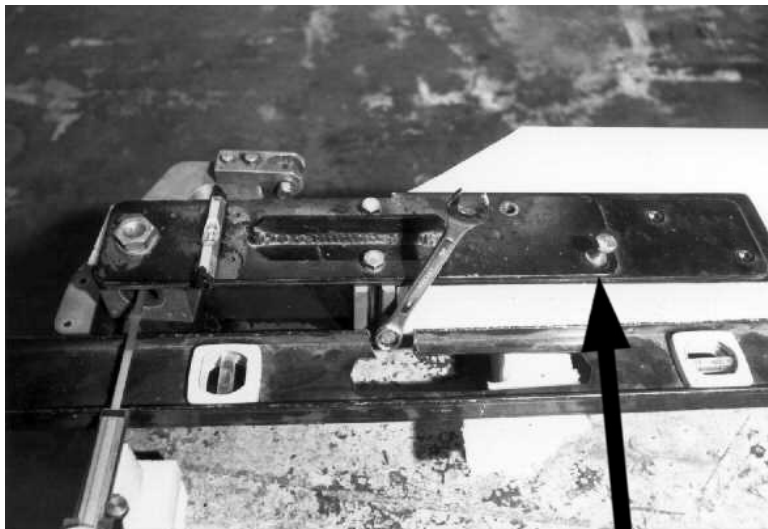

Photo #33

Drill out the holes in the blades for the remaining bolts and install them. Torque the bolts to 14 foot pounds. Remove the thrust block and make the following checks:

1. The distance between the straps. (2-1/4" to 2-3/8").
2. The straps are straight.
3. The 9/16" bolt goes in easy (normally only the paint in the holes must be removed to achieve this).

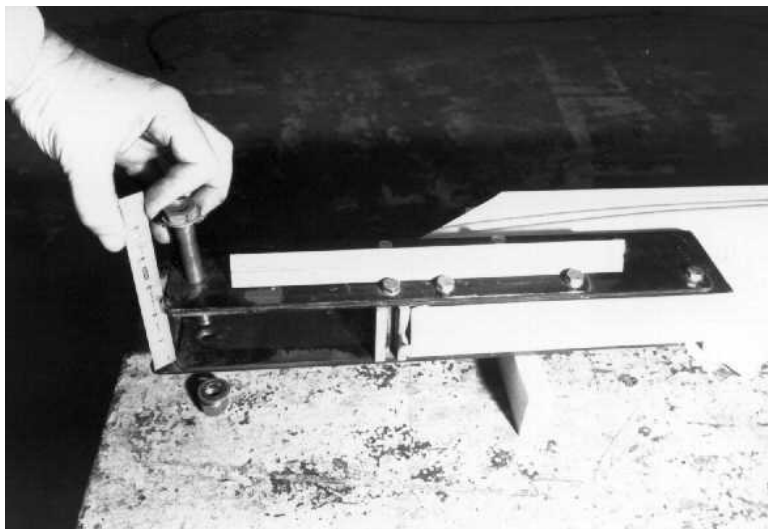

Photo #34



Install the thrust blocks on the inboard pitch pins. The one marked with "M" goes on the end of the hub with the serial number. Install the blades with the pitch horns and do the static lead/lag adjustment as follows:

1. Level the rotor hub by shimming under the skids.
2. Level the chord line of each blade. The blade must feather freely. Loosen the 5/16" aligner block bolts, then turn the 1/4" inch adjustment bolts until blades are level.

Note: If the blades do not feather freely during static lead/lag adjustment, check the gap between the aligner block bearing and the end of the hub plate. The gap should be approximately .040". The gap can be reduced by tapping the blade inward. This will relieve the friction of the elastomeric bearing. (Position the blade in the coning angle before tapping inward.)

Photo #35

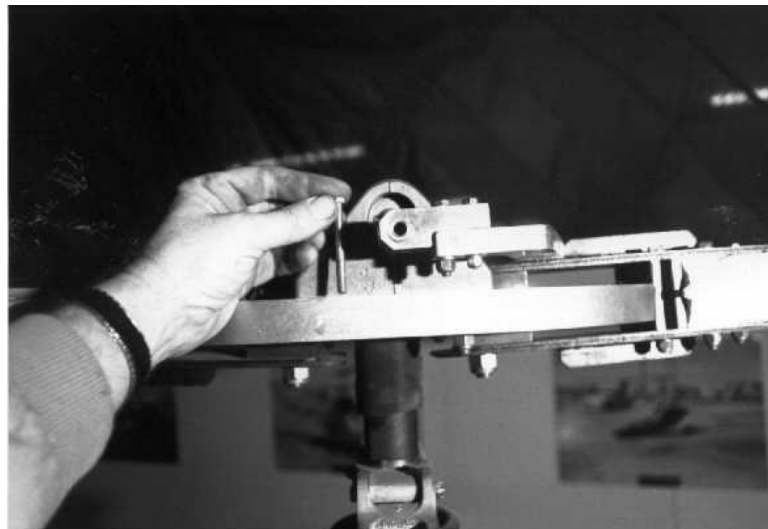

To do the static balance, remove the 3/8" bolts in the teeter blocks one at a time, replacing them with 1/4" bolts, nuts and washers. This will allow the blades to teeter freely. Remove weight from the tip weight on the heavier blade until the hub plate is level. End plugs and wood screws should be on top of the blades and even with the end when balancing the blades. See the Rotor Hub section of the Maintenance Manual for the correct procedures to remove the teeter block bolts.

Photo #36



Reinstall the 3/8" bolts in the teeter blocks. Grind a point on the end of a long 5/16" bolt and install it in the pitch horn clevis.

Photo #37

Lift the pitch horn high enough to allow the point of the 5/16" bolt to touch the main drive pin. The point of the bolt should align with the center of the drive pin. Rotate the pitch horn to achieve this alignment.

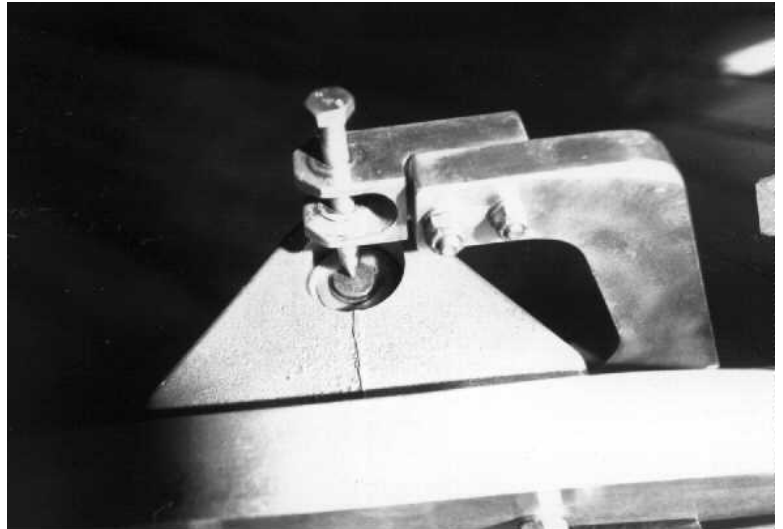

Photo #38

Connect the control rods between the swash plate and pitch horn clevis. Use long bolts on the swash plate and place a straight edge on them. Level the hub plate, straight edge on the swash plate bolts and chord line of both blades.

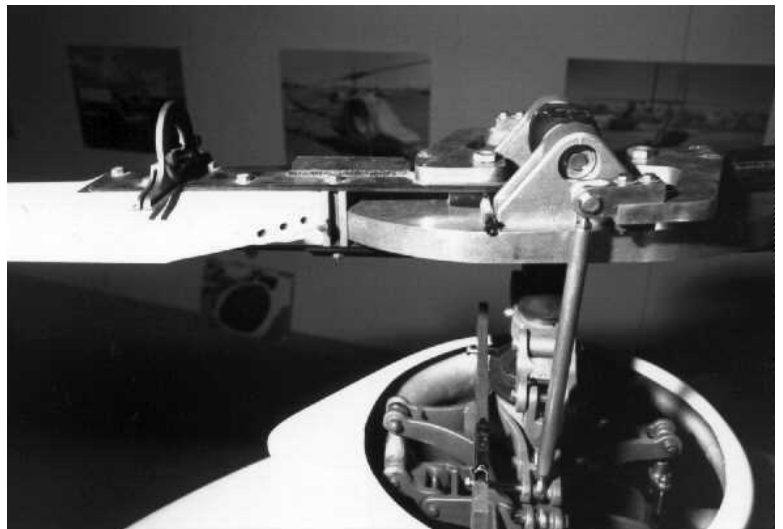

Photo #39

The distance between the main rotor shaft and the control rods, even with the bottom of the rotor hub, must be the same to maintain the same pitch on both blades at different collective positions.



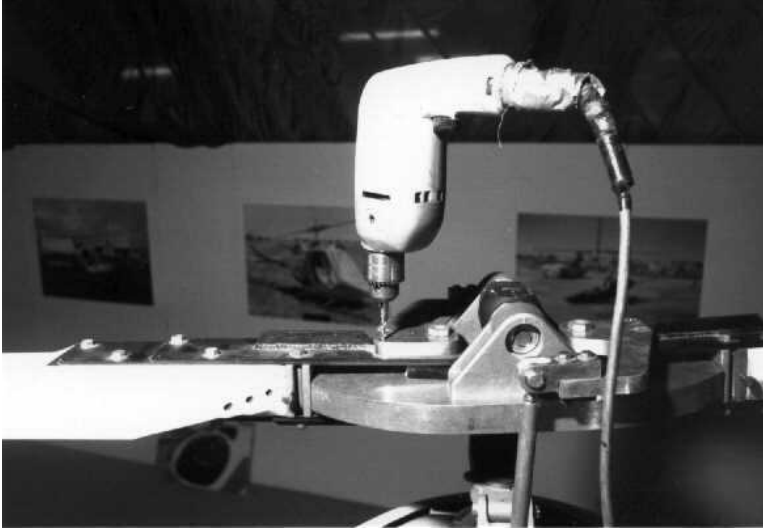

Photo #40

Make sure that the point of the 5/16" bolt aligns with the main drive pin and the distances are the same between the main rotor shaft and control rods. Using a drill with a 3/16" bit, mark the retention strap where it will be drilled for the bolt that will hold the pitch horn to the retention strap.



Photo #41

Slide the rubber collar on the main rotor shaft upward. Teeter the blades so they are 7-1/4 degrees to the shaft. Slide the rubber down until it rests on the retention strap and mark the edge of the strap. Remove the blades and drill the 3/16" hole for the pitch horn, and cut off the retention straps where they are marked.

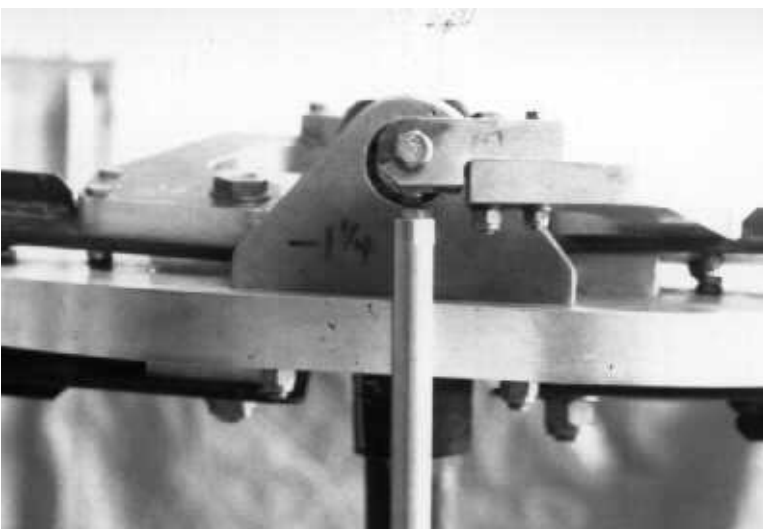

Photo #42

Install the 3/16" bolts in the pitch horn and the retention straps. Install the blades on the rotor hub and check all alignments.

REVIEW OF THE ROTOR SYSTEM RIGGING

1. Level the rotor hub laterally.
Shim under the skids.
2. Check the bias on the fore/aft and lateral cyclic control cables.
4 lbs. pull on the rod end to align the rod end with the slot in the swash plate.
3. Check the cyclic control freedom of travel from stop to stop.
52 degrees total travel fore/aft
52 degrees total travel lateral
4. Check the swash plate total travel 10 degrees in both directions.
5 degrees fore in reference to the main rotor shaft
5 degrees aft in reference to the main rotor shaft
5 degrees right in reference to the main rotor shaft
5 degrees left in reference to the main rotor shaft
5. Check the collective control for freedom of travel, from the bottom of the pocket in the floor pan to where it contacts the seat and airframe bracket.
6. Check the pitch on the main rotor blades.
Collective full down, the blades are set at 1-1/2 degrees, negative pitch on both blades.
Collective full up, the blades are set at 9-1/2 degrees, positive pitch on both blades.

Note: The swash plate must be 90 degrees to the main rotor shaft when setting the pitch on the main rotor blades.

7. Check to insure there is no binding of the control rod ends when the cyclic is at the lateral stops and the collective is full up. If necessary, material can be removed from the pitch horn clevis in areas where the rod end interferes. See illustration below.

